



Graphics Solutions for Professionals



# matrox **Extio Series**

Extio F1220 • Extio F1400 • Extio F1420

**User Guide**

10970-301-0110  
2007.03.07

---

# Overview

Thank you for purchasing a Matrox Extio product. This product is a complete remote graphics solution that supports up to 2 or 4 computer monitors at a time. As a remote graphics solution, it separates the CPU and hard disks of your system from the computer peripherals – monitors, keyboard, mouse, and audio hardware.

---

## Hardware supplied

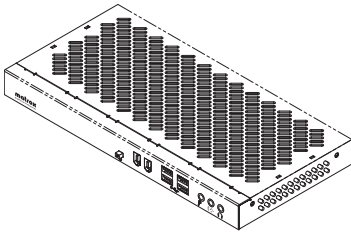

Matrox Extio remote graphics unit  
(Extio F1420 shown)

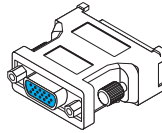

4 DVI-to-HD15 adapters  
(Extio F1400/F1420 only)

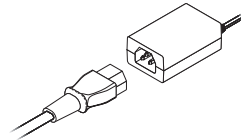

Power supply\*

\* Multiple power cables are provided for international support.

---

## Hardware required (sold separately)

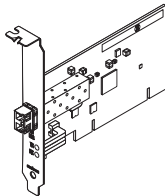

Matrox PCI or PCIe interface card  
(PCI card shown)

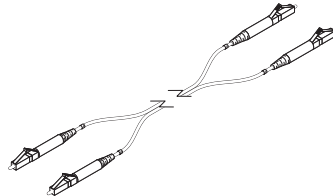

Dual LC optical cable  
(50 µm/125 µm or 62.5 µm/125 µm)

---

## Software available (for Windows 2000, Windows XP, Windows Server 2003, Windows XP Professional x64, and Windows Vista)

- Matrox PowerDesk-SE – to use your Matrox product
- Audio drivers – to use the audio hardware on your Matrox product
- Other software – see the CD-ROM *Readme* file

---

## Installation overview

To install your Matrox product:

- 1** Install your interface card – see “[Hardware installation](#)”, page 4.
- 2** Connect your Extio unit, monitors, and other peripherals – see “[Connection setup](#)”, page 7.
- 3** Install the software – see “[Software setup](#)”, page 11.

# Hardware installation

This section describes how to install a Matrox interface card in your host computer. If your Matrox interface card is already installed in your computer, skip to “[Connection setup](#)”, page 7. For information specific to your computer, like how to remove its cover, see your system manual.



**WARNING:** To avoid personal injury and to prevent damage to your computer or Matrox hardware, turn off your computer, unplug it, and then wait for it to cool before you install your Matrox product and touch any of the internal parts of your computer.

While your computer is turned off but still plugged in, some electrical current is supplied to the motherboard. This current may prevent newly installed hardware from working properly.

Also, static electricity can severely damage electronic parts. Before touching any electronic parts, drain static electricity from your body (for example, by touching the metal frame of your computer). When handling a card, carefully hold it by its edges and avoid touching its circuitry.

## 1 Open your computer and remove your existing graphics card \*

If a graphics card *isn't* already installed in your computer, skip to [step 2](#).

- a Using **Add/Remove Programs** in the Windows **Control Panel**, remove any currently installed display drivers. Restart your computer for the changes to take effect.

After your computer restarts, you're prompted to install drivers for the new graphics hardware detected. Click **Cancel**.

- b Turn off your computer and all peripherals such as your monitor or printer.
- c Open the computer and remove your existing graphics card. (If graphics hardware is built into the motherboard of your computer, you may need to disable it manually after your Matrox card is installed. For more information, see your system manual.)

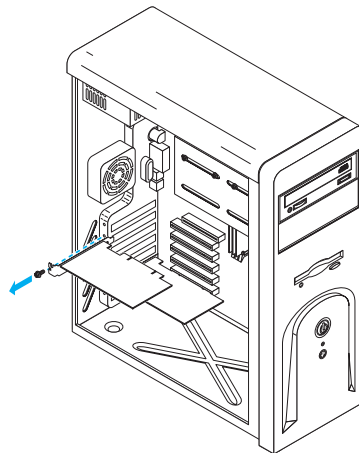

\* With multi-display mode, you may be able to use your existing graphics card. For Windows 2000/XP, see Windows 2000/XP online help under “Install additional monitors”.

## 2 Choose an expansion slot for your interface card

Most computers have different types of expansion slots. Choose a PCI or PCI Express (PCIe) ×1 slot, depending on the type of Matrox card you have. If you have a PCI card, your card supports both 64-bit and 32-bit PCI slots. Your system manual should identify the location of each type of expansion slot in your computer.

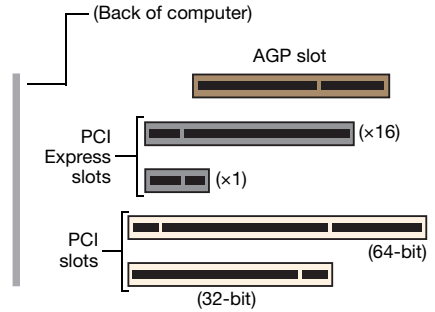

**Note:** If you're using a PCI card in a 64-bit PCI slot, your choice of PCI slot may affect your card or system performance. For more information, see your computer manual.



**WARNING:** Inserting your Matrox card into the wrong type of slot could damage your card, your computer, or both.

If you're using a PCI interface card in a 64-bit PCI expansion slot, your card uses only the part of your expansion slot closest to the back of the computer.

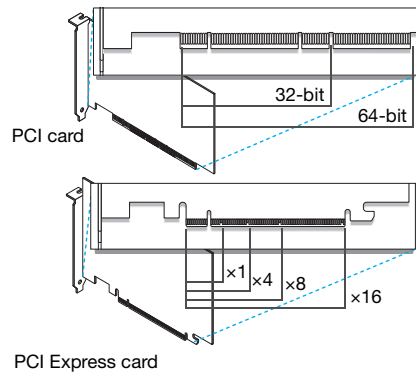

## 3 Insert your Matrox interface card

- Position your Matrox card over the expansion slot you've chosen.
- Push the card in firmly and evenly until it's fully seated in the slot.
- Secure the bracket of your Matrox card to the computer frame.

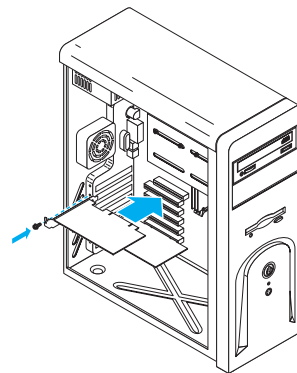

Your Matrox card is now installed. *Before restarting your computer*, first connect your Extio unit to your computer, then connect your monitors and your peripherals to your unit (see “[Connection setup](#)”, page 7). *After connecting*, restart your computer and install your Matrox software (see “[Software setup](#)”, page 11).



**WARNING:** If your computer doesn't restart after your Matrox card is installed, turn off your computer to avoid damaging electronic parts. For troubleshooting information, see [page 13](#).

# Connection setup

This section describes how to connect monitors and other peripherals to your Matrox Extio unit.

## Connection overview

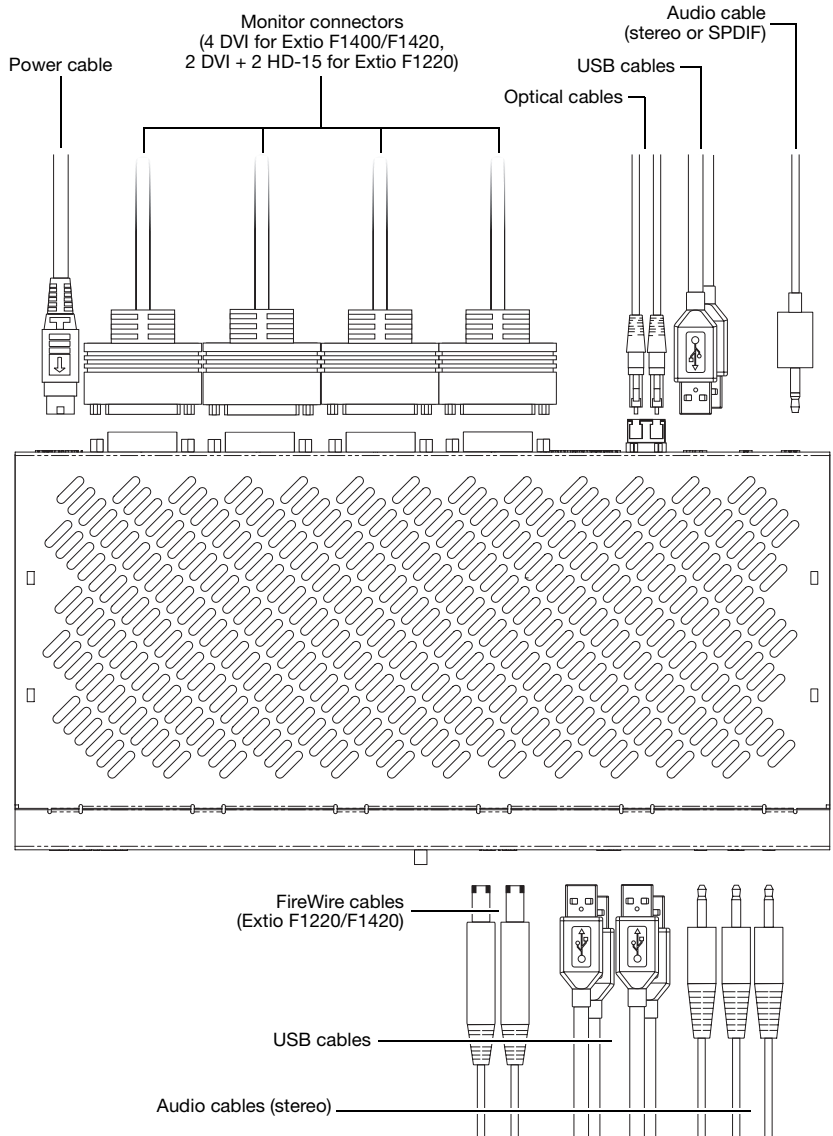

## Step-by-step connection setup



**WARNING:** Because the body of your Extio unit is used to disperse heat, it may become warm to the touch. Make sure your unit is located in a well ventilated area and nothing is blocking its ventilation holes.

### 1 Connect your unit to your interface card

To connect your Extio unit to your interface card, you need a dual LC optical cable (sold separately).

Connect one end of your optical cable to the optical connector of your interface card. Connect the other end of your cable to the optical connector on your unit. Make sure your connectors are properly connected.



**Note:** The maximum length of optical cable supported by your Matrox product is 250 meters/750 feet. For more information, see “[Product information](#)”, page 30.

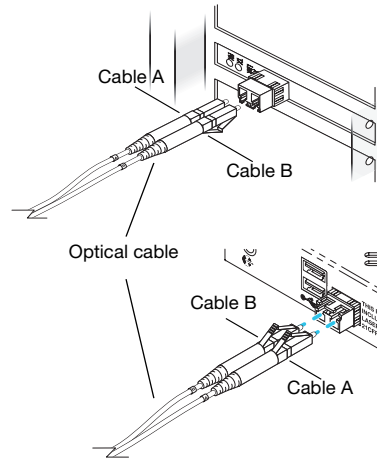

### 2 Connect your monitors

**Extio F1400/F1420** – Connect your monitors to the monitor connectors at the back of your Extio unit.

If your monitors have DVI connectors, connect them directly to the monitor connectors at the back of your unit.

If your monitors have HD-15 connectors, use DVI-to-HD15 adapters to connect your monitors to the monitor connectors at the back of your unit.

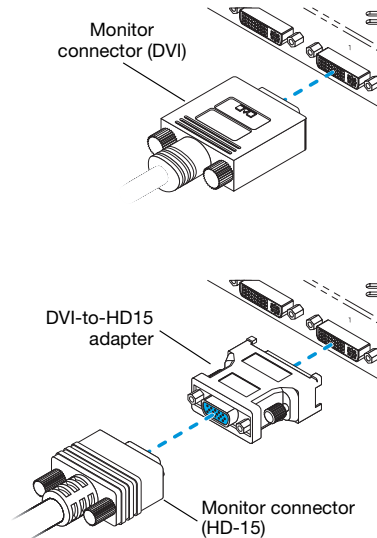

**Extio F1220** – Connect your monitors to the monitor connectors at the back of your Extio unit.

If your monitors have DVI connectors, connect them directly to the DVI monitor connectors (**A**) at the back of your unit.

If your monitors have HD-15 connectors, connect them directly to the HD-15 monitor connectors (**B**) at the back of your unit.

**i** **Note:** While a monitor is connected to a DVI connector on your unit, the corresponding HD-15 connector is disabled.

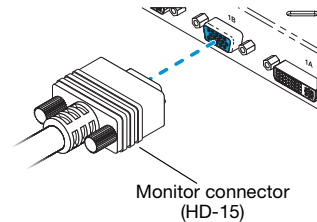
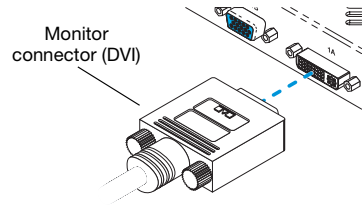

### 3 Connect the power supply

Attach one end of the power supply cable provided with your Matrox product to the power connector on your Matrox product.

Plug the power supply cord into an electrical outlet.

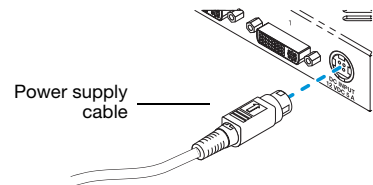

### 4 Connect your input devices (optional)

To use a keyboard or mouse, simply connect a USB mouse or keyboard to one of the USB connectors on your unit. There are 2 USB connectors at the back of the unit and 4 at the front.

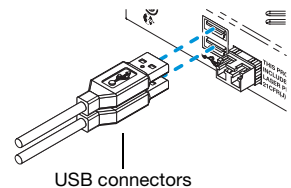

**i** **Note:** Your USB keyboard and mouse are unavailable until Windows starts.

## 5 Connect your FireWire devices (optional)

Extio F1220/F1420 – To use a FireWire device, simply connect it to one of the 2 FireWire connectors at the front of the unit.

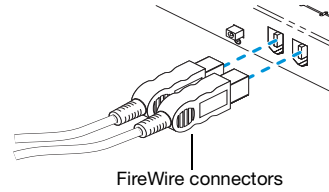

## 6 Connect your audio devices (optional)

Your unit has 2 input and 2 output audio connectors. The 2 input connectors are **Line in** (🔊) and **Microphone** (🎤). The 2 output audio connectors are **Headphones** (🎧) and **Line out** (🔊). All audio connectors support stereo jack connectors.

The **Line out** connector also supports *SPDIF* (Sony/Philips Digital Interface Format) mini-plug optical connectors.

To connect an audio device to your unit:

- a** Plug one end of your audio cable into the audio connector on your unit.
- b** Plug the other end of the cable in your audio device. For information on the type of connector supported by your audio device, see its documentation.

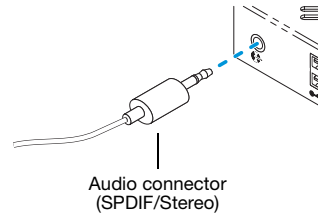

Your Matrox product is now installed. Restart your computer, and install your Matrox software (see “Software setup”, page 11).

---

# Software setup



**Note:** This guide has references that are specific to the Matrox installation CD-ROM. If your Matrox product wasn't packaged by Matrox (for example, if it was included with your computer), your product may not include this CD-ROM.

If you don't have this CD-ROM, certain references in this guide may not reflect the software you have. For more information, see other software documentation provided by your system vendor.

This section describes how to install Matrox software for *Windows 2000*, *Windows Server 2003*, *Windows XP*, *Windows XP Professional x64*, and *Windows Vista*.

You may need administrator rights to install certain software. For more information, see Windows documentation or contact your system administrator.

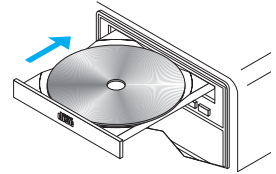

## 1 Install hardware drivers

Windows detects the hardware in your Matrox Extio unit as soon as the connection between the interface card and the unit is established. Depending on the version of your Matrox product, the drivers you need to install vary. If drivers for the hardware in your unit haven't been previously installed, Windows prompts you to install a driver for each component. Follow the on-screen instructions. (The Matrox 32-bit and 64-bit display drivers are in the *Win2kXP* and *WinXP64* folders of your Matrox installation CD-ROM.)



**Note:** Windows XP SP2 (Service Pack 2) – Windows may install a Matrox display driver unsupported by your product when the hardware in your unit is detected. If you aren't prompted to install a display driver, **DON'T RESTART** your system. Manually install the display driver on your Matrox installation CD-ROM before you restart.



## 2 Install optional software

After your computer has restarted, insert (or reinsert) the Matrox installation CD-ROM in your CD-ROM drive – the CD-ROM installation program automatically starts.\* This program shows you a list of items you can install and information you can access. Follow the on-screen instructions.

---

\* If Windows doesn't automatically start the setup program, you can start it manually from the root folder of the CD-ROM.

### 3 Set up your display software

Use Matrox PowerDesk software to change certain display settings or access Matrox features. To access PowerDesk, click its icon (  ) on your Windows taskbar. To see the PowerDesk icon in Windows XP/Vista, you may need to click the **Show hidden icons** button (  ) on your Windows taskbar. For more information on how to use Matrox PowerDesk, see the online help.

**Windows Server 2003** – To be able to use PowerDesk Multi-Display Setup with your Matrox product, you need to enable hardware acceleration on all the displays supported by your Matrox product. If hardware acceleration isn't enabled on a display, PowerDesk may not work properly.

To enable hardware acceleration, right-click your Windows desktop background, then click **Properties** → **Settings** → **Advanced** → **Troubleshoot**. Set the **Hardware Acceleration** slider to **Full**.

### 4 Configure your audio settings

If you've installed an audio driver for your Matrox product, make sure the audio hardware in your unit is enabled.

**a** Open the Windows **Audio** property sheet:

**Windows 2000** – Click **Start** → **Settings** → **Control Panel** → **Multimedia** or **Sounds and Multimedia** (double-click) → **Audio**.

**Windows XP** – Click **Start** → **Settings\*** → **Control Panel** → **Sounds, Speech, and Audio Devices\*** → **Sounds and Audio Devices** → **Audio**. (\* Depending on your configuration of Windows, this part of the step may not be necessary.)

**Windows Vista** – Click **Start** → **Settings\*** → **Control Panel** → **Hardware and Sound\*** → **Sound**. (\* Depending on your configuration of Windows, this part of the step may not be necessary.)

**b** **Windows 2000/XP** – Under **Sound playback** and **Sound recording**, select **Matrox Audio Device** as the default device. Make sure **Use only default devices** is enabled.

**Windows Vista** – In the **Playback** property sheet, select **Speakers (Matrox Audio Device)**, then click **Set Default**. This also enables **Digital Output (Matrox Audio Device)**.

In the **Recording** property sheet, select the **Matrox Audio Device** you want to use, then click **Set Default**.

**c** Click **OK**.



**Note:** If audio hardware is built into the motherboard of your computer, you may need to disable it manually before you can use the audio hardware in your Matrox Extio unit.

---

# Troubleshooting

---

## Basic procedures

This section explains basic procedures that are referred to by some troubleshooting items in this guide.

### Restarting in VGA mode

Windows 2000/XP/Vista – What follows is information on how to restart your computer in *VGA mode*.

- 1 Click **Start** → **Shut Down** → **Restart** → **OK\*** to restart your computer. (\* Depending on your version and configuration of Windows, this part of the step may not be necessary.)  
If your primary monitor is unusable, see your system manual for information on how to restart your computer using a hardware control.
- 2 *Before* Windows starts, press [F8] for the Windows startup menu to appear.
- 3 Select “VGA mode” (or “Low resolution mode”), then press [Enter].



**Note:** If your system stops responding while it's in VGA mode, select “Safe mode” instead.

---

## Graphics – Main troubleshooting

This section addresses possible problems that could prevent you from using your computer.

### Problem **Computer doesn't restart after Matrox card is installed**

**Cause** Your Matrox card may not be properly installed.

**Solution** Make sure your Matrox card is properly installed. Specifically, make sure the card is firmly inserted in its expansion slot and that all connections to it are firmly in place. For more information, see “[Hardware installation](#)”, page 4.

**Cause** There may be unsupported graphics hardware in your computer.

**Solution** If an unsupported graphics card is plugged into an expansion slot, remove it.

**Solution** If graphics hardware is built into your computer motherboard, your system may not have automatically disabled it when you inserted your Matrox card. Check your system manual for instructions on how to disable your computer built-in graphics hardware.

**Cause** The problem may be specific to the motherboard in your computer.

**Solution** There may be a software update available for your motherboard. To find out what motherboard model your computer is using, see your system manual. For more information, contact the manufacturer of your motherboard or computer. Many motherboard or computer manufacturers have software updates available on their Web site.

**Cause** Your Extio unit may not be properly connected to the interface card.

**Solution** **Interface card** – While your computer is turned on, make sure both the transmission (**TX**) and reception (**RX**) indicator lights on the bracket of your interface card are green. If the reception indicator is red and you have separate optical cables, switch the cables in the optical connector of your Matrox product. For more information, see [“Connect your unit to your interface card”](#), page 8.

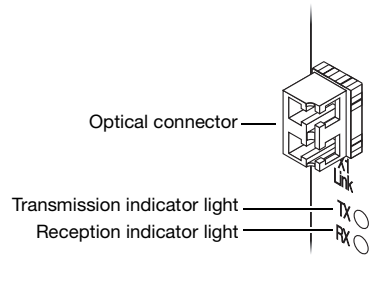

If the transmission indicator is red, your optical connector may be loose. Make sure your optical connector is firmly in place by pushing it into its housing. If the light doesn't change to green, contact your Matrox representative.

**Solution** **Unit** – While your unit is turned on, make sure the reception indicator light is off. This indicator light is inside your unit next to the optical connector. If the indicator light is on (red) and you have separate optical cables, switch the cables in the optical connector of your Matrox product. For more information, see [“Connect your unit to your interface card”](#), page 8.

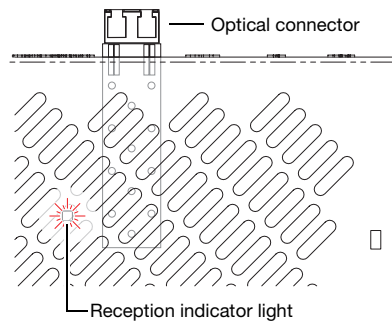

**Cause** Your optical cable may be defective.

**Solution** Change your optical cable.

## **Problem Wrong color balance, screen image off-center, or no picture at all**

**Cause** Windows XP Service Pack 2 – Windows Service Pack 2 has installed a version of the Matrox display driver that doesn't support your Matrox product.

**Solution** You need to install a display driver that supports your Matrox product. To reinstall the display driver, you first need to restart your computer in VGA mode (see “Restarting in VGA mode”, page 13). While in VGA mode, install the Matrox display driver on the installation CD-ROM provided with your product. If no CD was provided with your product, see the Matrox Technical Support Web site ([www.matrox.com/graphics/support/drivers](http://www.matrox.com/graphics/support/drivers)) to download a display driver.

**Cause** Your unit or your host computer may be turned off.

**Solution** Make sure the power supply is properly connected to your unit. Make sure both your unit and your host computer are turned on.

**Cause** Your interface card may not have been detected. Also, your computer may have re-enabled your built-in graphics hardware.

**Solution** To disable your built-in graphics card and re-enable your interface card:

- 1** Connect a monitor to the graphics connector at the back of your monitor.
- 2** Disable your built-in graphics hardware.

Windows 2000/XP –

- a** Click **Start** → **Settings\*** → **Control Panel** → **Performance and Maintenance\*** → **System** (double-click\*) → **Hardware** → **Device Manager**. (\* Depending on your version and configuration of Windows, this part of the step may not be necessary.)
- b** Double-click the **Graphics Adapter** list item to expand it, then double-click the name of your built-in graphics hardware.
- c** Under **Device usage**, select **Do not use this device (disable)**.
- d** Click **OK** to accept the changes, then close the Device Manager dialog box.

Windows Vista –

- a** Click **Start** → **Settings\*** → **Control Panel** → **Hardware and Sound\*** → **Device Manager** → **Continue\***. (\* Depending on your version and configuration of Windows, this part of the step may not be necessary.)
- b** Double-click the **Graphics Adapter** list item to expand it, then double-click the name of your built-in graphics hardware.
- c** Click **Driver** → **Disable** → **Yes**.
- d** Click **OK**, then close the Device Manager dialog box.

- 3 Shut down and unplug your computer. Disconnect all other peripherals from your computer for at least 1 minute, then restart your computer.

**Cause** Your monitor may not be properly connected.

**Solution** Make sure your monitor is properly connected to the connector on your unit (see “[Connect your monitors](#)”, page 8).

**Solution** Make sure the monitor power cable is firmly in place.

**Solution** Make sure the connection to the back of the monitor is firmly in place.

**Cause** If your monitor supports multiple input sources (analog/digital), it may be configured to use the wrong source.

**Solution** Make sure your monitor is using the correct input source. For more information on selecting the input source for your monitor, see your monitor documentation.

**Solution** Change your connection setup to use a different input source. For more information, see “[Connect your monitors](#)”, page 8.

**Problem** **After the startup screen, or after display settings are changed, the screen image is garbled or unusable**  
(blank screen, rolling or overlapping screen images)

**Cause** **Analog monitors only** – The Matrox display driver may be trying to use settings your monitor doesn’t support. This can happen if the display resolution was changed to one your monitor doesn’t support or if the monitor connected to your computer was changed without changing the display or monitor settings in the software.



**WARNING:** If incorrect software monitor settings are applied, *some* monitors can be permanently damaged. For more information, see your monitor manual.

**Solution** Make sure your monitor supports the display mode currently in use. After installing your Matrox product, your system is usually using the preferred display mode for your monitor or a display mode of 800 × 600 at 60 Hz.



**Note:** In multi-display mode, all the monitors connected to your unit use the same monitor settings. While using Windows display controls, all monitors use the settings of the main monitor (the monitor connected to connector #1 of your Matrox product). While using advanced Matrox display controls, the monitor settings for your monitors are determined by Matrox PowerDesk. Make sure you’re using monitor settings supported by your monitors.

**Solution** If none of your displays are available, reinstall your Matrox display drivers. For more information on reinstalling your display driver, see the following solution.

**Cause** Files on your system may have been deleted or corrupted.

**Solution** Remove, then reinstall Matrox software:



**Note:** Before removing software, make sure you have all the necessary files to reinstall software that may still be needed. Also, make sure the display driver you reinstall supports *all* Matrox products in your computer.

**Windows 2000/XP/Vista –**

- 1 If your primary display is currently unusable, restart your computer in VGA mode (see “Restarting in VGA mode”, page 13).
- 2 To remove Matrox software:

**Windows 2000/XP –**

- a Click **Start** → **Settings\*** → **Control Panel** → **Add/Remove Programs** (double-click\*) **Matrox Driver** → **Change/Remove** → **Yes**. (\* Depending on your version and configuration of Windows, this part of the step may not be necessary.)
- b Click **No** if you’re asked to restart your computer.
- c Click **Matrox PowerDesk-SE** → **Change/Remove** → **Yes**.

**Windows Vista –**

- a Click **Start** → **Settings\*** → **Control Panel** → **Programs\*** → **Program and Features** → **Matrox Driver** → **Uninstall** → **Yes**. (\* Depending on your version and configuration of Windows, this part of the step may not be necessary.)
  - b Click **No** if you’re asked to restart your computer.
  - c Click **Matrox PowerDesk-SE** → **Uninstall/Change** → **Yes**.
- 3 Restart your computer.
  - 4 After removing Matrox software, install the latest display driver for your Matrox product. You may also need to reinstall other Matrox software.



**Note:** Windows 2000/XP/Vista – You may need administrator rights to remove certain software. For more information, see Windows documentation.

---

## Graphics – Extra troubleshooting

The following are extra troubleshooting items related to your graphics hardware.

### **Problem** Can't use Windows, Windows reports a configuration error, and/or can't install or uninstall display driver



**Note:** Windows 2000/XP/Vista – You may need administrator rights to install certain software. For more information, see Windows documentation.

**Cause** The problem may be specific to the motherboard in your computer.

**Solution** There may be a software update available for your motherboard. To find out what motherboard model your computer is using, see your system manual. For more information, contact the maker of your motherboard or computer. Many motherboard or computer manufacturers have software updates available on their Web site.

**Cause** Files on your system may have been deleted or corrupted.

**Solution** Remove, then reinstall Matrox software. For more information, [see page 17](#).

### **Problem** Monitor settings aren't automatically detected



**WARNING:** If incorrect software monitor settings are used, your display may become unusable and *some* monitors can be permanently damaged. For more information, see your monitor manual.

**Cause** Your monitor may not be Plug-and-Play. Most new monitors are Plug-and-Play but many older ones aren't. Software can't automatically detect settings for monitors that aren't Plug-and-Play.

**Solution** Restart your computer. If your monitor is a Plug-and-Play (DDC) monitor, it should be automatically detected by the software.

### **Problem** Built-in network hardware doesn't work after interface card is installed

**Cause** The installation of an interface card may have caused your computer to reallocate system resources.

**Solution** Try reinstalling your network drivers.

**Solution** Try moving your Matrox interface card to another PCI (or PCIe depending on your product) slot in your computer. For instructions on how to safely install your Matrox card, see [“Hardware installation”, page 4.](#)

## **Problem** **W** **Using multiple displays under Windows 2000/XP/Vista, program doesn't work with your Matrox product**

**Cause** Your Matrox product may not be controlling your primary display. The graphics hardware that controls your primary display is the one that first displays information when you restart your computer.

A program that doesn't recognize multiple displays may not work with your Matrox product unless it's controlling your primary display.

Your computer BIOS (Basic Input/Output System) and the slot type (AGP, PCI, or PCIe – see [“Choose an expansion slot for your interface card”, page 5](#)) of each graphics card and of your interface card help determine which graphics hardware controls your primary display.

**Solution** If you're having problems with a program that can be moved on your Windows desktop, run this program on your primary display. Make sure the program window doesn't overlap any other display. If the program doesn't work with the graphics hardware controlling your primary display, or you want your Matrox product to control your primary display, see the other solutions.

**Solution** Change the configuration of your computer BIOS so that the slot type of your interface card has priority for controlling the primary display. For information on how to change your computer BIOS settings, see your system manual.

If your computer BIOS doesn't let you select which slot type has priority for becoming the primary display, a BIOS update may be available to let you do this. (The BIOS of most computers can be updated with software.) For a possible BIOS update for your computer, contact your system vendor.

**Solution** If there's a graphics controller built into the motherboard of your computer, by changing your computer BIOS settings, you may be able to change which device controls your primary display. For more information, see your system manual.

**Solution** If you don't need to use the graphics card that's controlling your primary display, remove it from your computer. If your primary display is controlled by the motherboard of your computer, see your system manual for information on how to disable this graphics controller.

**Cause** The program you're using may not work properly with systems using more than one display at a time.

**Solution** An update may be available for the program you're using. This update may fix problems this program has with multi-display systems. For more information, contact the software distributor for the program you're using.

**Problem** **Not all graphics hardware in the computer is fully supported**  
(Software doesn't work with a certain graphics card, or another graphics card doesn't work at all)

**Cause** If you're using graphics hardware other than the graphics hardware in your Matrox Extio product, your display driver may not support both the graphics hardware in your Matrox product and the one in your computer.

Under Windows 2000/XP/Vista, you can use different display drivers for different products. Software that depends on a specific display driver feature may not work if your graphics hardware is using different display drivers.



**Note:** If your Matrox product was provided by the manufacturer of your computer, check the Web site of that manufacturer for the latest display driver. A display driver provided by the manufacturer of your computer is more likely to be tested with your computer model.

**Solution** If a graphics card isn't supported, you may need to remove it. If there's graphics hardware built into the motherboard of your computer that's not supported by your software, see your system manual for information on how to disable this graphics hardware.

**Cause** **Windows 2000/XP/Vista** – If the Windows method for display driver installation was used (instead of running the setup program included with your Matrox display driver), the driver may not be installed for all the Matrox products it supports.

**Solution** Run the setup program included with the Matrox display driver. The setup program automatically installs the display driver for each Matrox product it supports.

**Problem** **In multi-display mode, displays aren't numbered consecutively**

**Cause** If you're using graphics hardware other than the graphics hardware in your Matrox Extio product, the display numbering may not be consecutive for the displays of your Matrox product. Display numbering depends on your graphics hardware and the BIOS settings of your computer.



**Solution** **Windows 2000/XP/Vista** – Move the displays in Windows.

- 1** **Windows 2000/XP** – Right-click your Windows desktop background, then click **Properties** → **Settings**.

Windows Vista – Right-click your Windows desktop background, then click **Personalize** → **Display Settings**.

- 2 Select a display and move it according to the physical position of the monitor it's associated with.
- 3 Click **OK**.

**Problem** **Screen image defects appear, program doesn't run properly, or Windows doesn't work properly**  
(example: mouse pointer not drawn properly)

**Cause** Some programs may not work properly with some acceleration.

**Solution** Windows 2000/XP/Vista – Disable Windows effects:

Windows 2000 –

- 1 Right-click your Windows desktop background, then click **Properties** → **Effects**.
- 2 Disable one or more features under **Visual effects**.
- 3 Click **OK** → **OK**.

Windows XP –

- 1 Right-click your Windows desktop background, then click **Properties** → **Appearance** → **Effects**.
- 2 Disable one or more features.
- 3 Click **OK** → **OK**.

Windows Vista –

- 1 Right-click your Windows desktop background, then click **Personalize** → **Window Color and Appearance**.
- 2 If you're using Windows Aero scheme, click **Open classic appearance properties for more color options**. Under **Color scheme**, select **Windows Vista Basic**.
- 3 Click **Effects** and then disable one or more features.
- 4 Click **OK** → **OK**.

**Solution** Windows Vista – Disable the Windows Aero features. Right-click your Windows background, then click **Personalize** → **Theme**. Under **Desktop theme**, select Windows Vista or Windows Classic.

**Solution** If possible, update your Matrox display driver. Matrox makes new display drivers available on the Matrox Technical Support Web site ([www.matrox.com/graphics/support/drivers](http://www.matrox.com/graphics/support/drivers)).

 **Note:** If your Matrox product was provided by the manufacturer of your computer, check the Web site of that manufacturer for the latest display driver. A display driver provided by the manufacturer of your computer is more likely to be tested with your computer model.

 **Note:** If you identify a program that doesn't work well with Matrox acceleration, please contact Matrox technical support (see page 32) and describe the problem. This information may help us come up with a fix or work-around in a future driver release.

## **Problem Program window or dialog box doesn't appear on screen**

**Cause** Another window or dialog box may be covering the window or dialog box you want to see.

**Solution** Move, close, or minimize any window or dialog box that may be covering the window or dialog box you want to see.

**Cause** If you're using multi-display mode, the program window or dialog box may be in a display or on a monitor that's unusable. (For example, your monitor may not be properly connected or configured.)

**Solution** Make sure all the displays and monitors you want to use are usable. For more information, see other troubleshooting items in this guide.

**Cause** If you're using graphics hardware other than the graphics hardware in your Extio unit, the program window or dialog box may be in a display controlled by the graphics hardware in your computer.

**Solution** If you're using your unit in a remote location from the host computer, disable any display controlled by the graphics hardware in your computer.

### **Windows 2000/XP –**

- 1** Right-click your Windows desktop background, then click **Properties** → **Settings**.
- 2** Select the display you want to disable, then clear the **Extend my Windows desktop onto this monitor** check box.
- 3** Click **OK**.

### **Windows Vista –**

- 1** Right-click your Windows desktop background, then click **Personalize** → **Display settings**.

- 2 Select the display you want to disable, then clear the **Extend the desktop onto this monitor** check box.
- 3 Click **OK**.

**Cause** The software may be using a display you didn't intend to use or the software may be configured to use more displays than the actual number of monitors you have.

**Solution** Disable the display:

Windows 2000/XP –

- 1 Right-click your Windows desktop background, then click **Properties** → **Settings**.
- 2 Select the display you want to disable, then clear the **Extend my Windows desktop onto this monitor** check box.
- 3 Click **OK**.

Windows Vista –

- 1 Right-click your Windows desktop background, then click **Personalize** → **Display settings**.
- 2 Select the display you want to disable, then clear the **Extend the desktop onto this monitor** check box.
- 3 Click **OK**.

**Cause** The program window or dialog box may be somewhere off-screen.

**Solution** If the program window you want to see is named on the Windows taskbar, right-click it and select **Maximize**. (If you click **Restore** the program window goes back to its previous position. To fix this problem, see the other solutions.)

**Solution** Manually move the program window or dialog box:

- 1 Press [Alt]+[Space].
- 2 If you see a pop-up menu, click **Move**. If you don't see a pop-up menu, press [M] (for **Move**).
- 3 Press one of the arrow keys once and move your mouse pointer to where you want the window or dialog box to appear, then click that spot on your Windows desktop. The program window or dialog box should appear where you clicked.

**Solution** Windows 2000/XP/Vista –

- 1 Click the Matrox PowerDesk icon () on your Windows taskbar, then click **Desktop Management**.

- 2 Enable one or more of the following features:
  - **Open program windows**
  - **Center dialog boxes and message boxes**
- 3 Choose where you want the program window or dialog box to appear.

For more information, see Matrox PowerDesk help.

## **Problem Display on digital monitor appears blurry or uses only a portion of the screen**

**Cause** You may be using a lower display resolution than what your digital monitor supports. If your monitor supports display scaling, the image on your screen may appear blurry. If display scaling isn't supported, the display may use only a portion of your screen.

**Solution** Select the highest display resolution available. This generally results in better image quality.

---

## **Video**

The following troubleshooting items address problems related to video files.

### **Problem Video file playback is jerky (skipping frames)**



**Note:** Jerky video file playback may be the result of slow playback or recording. Slow recording causes frames to be dropped (frames aren't recorded). If jerky video is caused by frames that were dropped during recording, the problem can only be fixed by recapturing the video under better conditions.

**Cause** Your hard disk may be too slow.

**Solution** Try *defragmenting* your hard disk.

**Windows 2000/XP** – To defragment a hard disk, click **Start** → **Programs** (or **All Programs**) → **Accessories** → **System Tools** → **Disk Defragmenter**.

**Windows Vista** – To defragment a hard disk, click **Start** → **Settings** → **Control Panel** → **Performance Information and Tools** → **Advanced Tools** → **Open Disk Defragmenter**.

**Solution** If possible, try using a faster disk.



**Tip:** If your computer has more than one hard disk, you may get better results if you play back or capture video files with a disk *other than* the one where the Windows swap file is stored. The Windows swap file is usually stored on drive “C:”.

**Solution** Make sure the drive you’re using (a hard disk or DVD drive) is using DMA (if your drive supports DMA transfers). To use DMA:



**WARNING:** Not all drives support DMA well. For more information, see the documentation that came with your hard disk.

**Windows 2000/XP –**

- 1 Click **Start** → **Settings\*** → **Control Panel** → **Performance and Maintenance\*** → **System** (double-click\*) → **Hardware** → **Device Manager**. (\* Depending on your version and configuration of Windows, this part of the step may not be necessary.)
- 2 Double-click the **IDE ATA/ATAPI controllers** list item to expand it, then double-click the name of the appropriate controller.
- 3 Change each **Transfer Mode** setting to “**DMA if available**”.
- 4 Click **OK** to accept the changes.

**Cause** Too many programs may be running (using up computer resources).

**Solution** Close other programs, including memory-resident programs like **System Agent**.

**Cause** Your display settings may be too high. As a result, video file playback may not be fully supported by your Matrox hardware.

**Solution** Try lowering your display settings (resolution, color palette, and/or refresh rate).

**Windows 2000/XP –** To access display settings, right-click your Windows desktop background, then click **Properties** → **Settings**.

**Windows Vista –** To access display settings, right-click your Windows desktop background, then click **Personalize** → **Display Settings**.

## **Problem Mouse pointer flickers or disappears when it's over a video window**

**Cause** You may be using a customized mouse pointer. Windows draws customized mouse pointers in a way that may cause them to flicker or disappear while they're over a video window.

**Solution** Windows 2000/XP/Vista – Use default Windows mouse pointers:

**1** Windows 2000/XP – Click **Start** → **Settings\*** → **Control Panel** → **Printers and Other Hardware\*** → **Mouse** (double-click\*). (\* Depending on your version and configuration of Windows, this part of the step may not be necessary.)

Windows Vista – Click **Start** → **Settings\*** → **Control Panel** → **Hardware and Sound \*** → **Mouse** (double-click\*). (\* Depending on your version and configuration of Windows, this part of the step may not be necessary.)

**2** Click the **Pointers** tab.

**3** In the **Scheme** box, select (or reselect) “**(None)**”; then click **OK**.

---

## **Sound**

The following troubleshooting items address problems related to the audio output of your unit.

### **Problem Sound doesn't record, video files play back with no sound, or sound output is distorted or too loud**

**Cause** If the sound problem is with a particular device (for example, TV or speaker), the volume control on the device itself may need adjusting.

**Solution** Adjust the volume control on the device itself.

**Cause** Audio cables may be loose or incorrectly wired.

**Solution** Make sure your audio cables are properly connected.

**Cause** Windows may be using the audio hardware in your computer rather than the audio hardware in your Matrox product.

**Solution** Make sure the audio hardware of your Matrox product is set as the default audio device and that only the default audio device is used. For more information, see “[Configure your audio settings](#)”; page 12.

**Cause** Windows audio settings may be incorrect. Specifically, input or output may be disabled, or volume levels may be too low or too high.

**Solution** Make sure your Windows audio settings are correct:

## Windows 2000/XP –

- 1 Double-click the speaker icon (🔊 or 🎧) on the Windows taskbar.

If you *don't* see the speaker icon:

### Windows 2000 –

- a Click **Start** → **Settings** → **Control Panel**.
- b Double-click the **Multimedia** or **Sounds and Multimedia** icon.
- c Enable the “**Show volume control on the taskbar**” check box.
- d Click **OK**.
- e Double-click the speaker icon on the taskbar.

### Windows XP –

- a Click **Start** → **Settings\*** → **Control Panel** → **Sound, Speech, and Audio Devices\*** → **Sounds and Audio Devices**. (\* Depending on your configuration of Windows, this part of the step may not be necessary.)
  - b Enable the “**Place volume icon in the taskbar**” check box.
  - c Click **OK**.
  - d Double-click the speaker icon on the taskbar.
- 2 Click **Options** → **Properties**.
  - 3 Click the **Recording** button, enable all check boxes in the list box, then click **OK**.
  - 4 For the **Line In** and/or **Microphone** controls, make sure the **Volume** slider levels are okay (if you're not sure, try half level), and the appropriate **Select** check box is enabled.
  - 5 Click **Options** → **Properties**.
  - 6 Click the **Playback** button, enable all check boxes in the list box, then click **OK**.
  - 7 For the **Master**, **Line**, and/or **Wave** controls, make sure the **Volume** sliders are at one-quarter to one-half levels (if you're not sure, try half level), and the **Mute** check boxes are cleared.
  - 8 Close the dialog box.

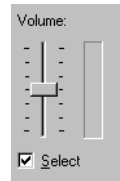



**Note:** Depending on your sound driver, certain labels may be different. For example, **Line In** may be labeled **Line**.

## Windows Vista –

- 1 Right-click the speaker icon () on the Windows taskbar.  
If you *don't* see the speaker icon:
  - a Right-click the taskbar and select **Properties** → **Notification area**.
  - b Under **System icons**, enable the **Volume** check box.
  - c Click **OK**.
  - d Right-click the speaker icon on the Windows taskbar.
- 2 Select **Playback** and make sure all the devices you want to use are listed as working. If a device is listed as not working, right-click the device icon and select **Enable**.



**Note:** To see all your devices, right-click anywhere on the property sheet and make sure **Show disabled devices** and **Show Disconnected Devices** are enabled.

- 3 For each device you want to use, double-click the device icon and select **Levels**. Make sure the volume slider value is okay and the volume button is enabled (). Click **OK**. (To test the volume of a playback device, right-click the device icon in the **Playback** property sheet and select **Test**.)
- 4 Select **Recording** and make sure all the devices you want to use are listed as working. If a device is listed as not working, right-click the device icon and select **Enable**.



**Note:** To see all your devices, right-click anywhere on the property sheet and make sure **Show disabled devices** and **Show Disconnected Devices** are enabled.

- 5 For each device you want to use, double-click the device icon and select **Levels**. Make sure the volume slider value is okay (if you're not sure, try a value of 50) and the volume button is enabled (). Click **OK**. (To test the volume of a recording device, make sure there is an audio source plugged into it and playing, then watch the volume meter next to the audio device icon. The volume meter should be between 60 and 100%.)

**Cause** The problem may be specific to the audio hardware of your computer.

**Solution** For more information, see the documentation for the audio hardware of your computer.

**Cause** Your system may have built-in audio hardware that conflicts with the audio hardware of your Matrox unit.



**Solution** Disable the built-in audio hardware in your system.

#### Windows 2000/XP –

- 1 Click **Start** → **Settings\*** → **Control Panel** → **Performance and Maintenance\*** → **System** → **Hardware** → **Device Manager**. (\* Depending on your configuration of Windows, this part of the step may not be necessary.)
- 2 Under **Sound, video and game controllers**, right-click your built-in audio hardware and select **Disable**. For more information on the audio hardware in your system, see your system manual.
- 3 Click **Yes** → **Yes**. For changes to take effect, your computer must be restarted.

#### Windows Vista –

- 1 Click **Start** → **Settings\*** → **Control Panel** → **System and Maintenance\*** → **System\*** → **Device Manager** → **Continue\***. (\* Depending on your configuration of Windows, this part of the step may not be necessary.)
- 2 Under **Sound, video and game controllers**, right-click your built-in audio hardware and select **Disable**. For more information on the audio hardware in your system, see your system manual.
- 3 Click **Yes**.

**Cause** Your **Line Out** connector () may be muted because you have another audio device connected to the **Headphones** connector (.

**Solution** Make sure nothing is connected to the **Headphones** connector at the front of your unit.

# Product information

## Extio unit features

	Matrox Extio F1220	Matrox Extio F1400	Matrox Extio F1420
<b>Digital monitor support</b>	DVI	DVI	DVI
<b># of displays supported</b>	2 (digital or analog)	4 (digital or analog)	4 (digital or analog)
<b>Interface card supported</b>	Optical	Optical	Optical
<b>Memory</b>	128 MB	128 MB	128 MB
<b># of DVI-to-HD15 adapters</b>	—	4	4
<b>USB support</b>	✓	✓	✓
<b>FireWire support</b>	✓	—	✓

## Interface card features

<b>Interface type</b>	Optical
<b>Card Type</b>	PCI or PCIe x1
<b>Form factor</b>	Low-profile
<b>Cable type supported</b>	Dual-LC optical
<b>Maximum distance</b> (cable type)	250 m (50 µm/125 µm) 150 m (62.5 µm/125 µm)

## Notes

- Your Matrox graphics hardware is 100% VGA compatible and supports all VESA standards: VBE 2.0 (Super VGA modes), DPMS (energy saving), and DDC-2B (Plug-and-Play monitor).
- To get the most of your Matrox product, we recommend using the highest color palette setting (a 32-bit color palette) for all your displays.
- The display resolutions and refresh rates available depend on your Matrox graphics hardware, display driver, software monitor settings, and monitor. For information on the capabilities of your monitor, see your monitor documentation.

- While using 4 displays at a time, your Matrox graphics hardware supports display resolutions up to 1600 × 1200 for each display (6400 × 1200 or 3200 × 2400) with a vertical refresh rate up to 60 Hz.
- If you're using multiple monitors, your Matrox hardware uses the same display resolution and monitor settings for all your monitors. The display resolution and monitor settings (such as refresh rate) will be the ones selected in Matrox PowerDesk multi-display settings.

### Supported VESA modes (main display)

In the table below, VESA modes supported by your Matrox graphics hardware are indicated by a VESA mode number. Many Super VGA DOS programs use VESA modes.

Display resolution	16 colors	256 colors	32 K colors	64 K colors	16 M colors
640 × 400	—	100	—	—	—
640 × 480	(VGA)	101	110	111	112
800 × 600	102	103	113	114	115
1024 × 768	—	105	116	117	118
1280 × 1024	—	107	119	11A	11B
1600 × 1200	—	11C	11D	11E	11F
			<b>Rows</b>		
Columns	25	43	50	60	
80	—	—	—	108	
132	109	10A	10B	10C	

---

# Customer support

---

## Matrox Web

Matrox is on the Internet with a World Wide Web (WWW) site. Our Web site has product literature, press releases, technical material, a sales office list, trade show information, and other relevant material.

- Visit the Matrox Graphics Web site at [www.matrox.com/graphics](http://www.matrox.com/graphics).
- E-mail questions or comments regarding the site to [webmaster@matrox.com](mailto:webmaster@matrox.com).

---

## If you have a problem

Matrox values your business and offers professional support for your Matrox product. For product support, contact your Matrox representative or visit our technical support Web site at [www.matrox.com/graphics/support/](http://www.matrox.com/graphics/support/).

### Information we need

Please give a complete description of the problem, and include:

- Matrox card serial number, model number, revision number, BIOS number, driver type and version, and memory address at which the Matrox card is installed.
- Computer brand and model name.
- Monitor brand and model name.
- Operating system, version, and service pack.
- Brand and model of any other cards and devices installed on your system.

### Program specific problems

If a problem appears with a specific program, please give us the following information:

- Display settings (color palette, display resolution, and so on) applied when the problem occurs.
- If possible, take note of the file and segment address that caused the problem.
- Detailed steps known to cause the bug, so we can reproduce it.

---

## Where to get information

For system information:

- Windows 2000 – Right-click the **My Computer** icon on your Windows desktop background, then click **Properties**.
- Windows 2000/XP – Click **Start** → **Programs** (or **All programs**) → **Accessories** → **System Tools** → **System Information**.
- Windows XP – Click **Start** → **Settings\*** → **Control Panel** → **Performance and Maintenance\*** → **System** (double-click\*). (\* Depending on your configuration of Windows, this part of the step may not be necessary.)
- Windows Vista – Click **Start** → **Settings\*** → **Control Panel** → **System and Maintenance** → **System**. (\* Depending on your configuration of Windows, this part of the step may not be necessary.)

---

# Warranty

---

## A. Limited Warranty Statement

1. Matrox Graphics Inc. (“Matrox”) warrants to the end-user customer, who provides adequate proof of purchase that Matrox hardware products purchased from Matrox authorized dealers will be free from defects in materials and workmanship for a period of two (2) years from the date of purchase. This warranty applies only to the original end-user purchaser and is non-transferable. Conditions and limitations of Matrox’s warranty are stated below.
2. Matrox’s limited warranty covers only those defects which arise as a result of normal use of the hardware and does not apply to any:
  - a. improper or inadequate maintenance;
  - b. incompatibilities due to the user’s hardware or software applications with or in which the Matrox product interfaces;
  - c. product of a special or custom-made nature;
  - d. unauthorized modification or misuse;
  - e. improper installation, misapplication or negligence;
  - f. operation outside the product’s environmental specifications;
  - g. improper site preparation or maintenance;
  - h. software;
  - i. other causes that do not relate to a product defect;
  - j. defects or damage suffered as a result of force majeure (including theft);
  - k. defects or damage suffered as a result of normal wear and tear, and/or
  - l. stolen goods.
3. If Matrox receives, during the applicable warranty period, notice of a defect in a warranted hardware product and the defective Matrox product in question, Matrox shall at its sole option, either repair or replace the product, and shall return the repaired product or a replacement product within a reasonable delay. The replacement product may not be new, provided that it has functionality at least equal to that of the product being replaced.
4. This warranty is valid in any country where Matrox hardware products are distributed by Matrox or its authorized dealers.
5. This Limited Warranty Statement gives the customer specific legal rights. The customer may also have other rights which vary from state to state in the United States, from province to province in Canada, and from country to country elsewhere in the world.

---

## B. Limitations of Warranty

1. NEITHER MATROX NOR ANY OF ITS THIRD PARTY SUPPLIERS MAKES ANY OTHER WARRANTY OF ANY KIND, WHETHER EXPRESSED OR IMPLIED, WITH RESPECT TO MATROX PRODUCTS. MATROX SPECIFICALLY DISCLAIMS (and the customer, by accepting the Matrox product, specifically accepts such disclaimer and waives) ALL OTHER WARRANTIES, EITHER EXPRESSED OR IMPLIED, INCLUDING BUT NOT LIMITED TO THE IMPLIED WARRANTIES OF MERCHANTABILITY AND FITNESS FOR A PARTICULAR OR INTENDED PURPOSE OR USE AND THE WARRANTY AGAINST LATENT DEFECTS, WITH RESPECT TO THE HARDWARE AND/OR SOFTWARE. MATROX FURTHER DISCLAIMS ANY WARRANTY THAT MATROX PRODUCTS, IN WHOLE OR IN PART, WILL BE FREE FROM INFRINGEMENT OF ANY THIRD PARTY INTELLECTUAL PROPERTY OR PROPRIETARY RIGHTS.
2. To the extent that this Limited Warranty Statement is inconsistent with the law of the locality where the customer purchases the Matrox product, this Limited Warranty Statement shall be deemed modified to be consistent with such local law. Under such local law, certain limitations of this Limited Warranty Statement may not apply to the consumer.
3. To the extent allowed by local law, the remedies provided in this Limited Warranty Statement are the customer’s sole and exclusive remedies.

---

## **C. Limitations of Liability**

1. EXCEPT FOR THE OBLIGATIONS SPECIFICALLY SET FORTH IN THE LIMITED WARRANTY STATEMENT, IN NO EVENT SHALL MATROX BE LIABLE FOR:
  - a. any direct, indirect, special, incidental, consequential, foreseeable or unforeseeable, or punitive damages, whether based on contract, tort, delict or any other legal theory and whether advised of the possibility of such damages, and/or
  - b. damages arising from the loss of use, data, production revenue and/or profit of in connection with the Matrox product or any business interruption.
2. Without prejudice to the foregoing, any liability of Matrox for any breach of warranty shall be limited to the amount paid by the customer for the defective hardware in question.
3. To the extent allowed by local law, Matrox's entire liability and the customer's exclusive remedy shall be the repair or replacement of any defective product during the warranty period. Matrox does not offer any other warranty with respect to Matrox hardware or software or any other hardware or software.
4. Customer shall be responsible for all applicable taxes, duties and customs fees on any replacement unit, as well as all transport, insurance, storage and other charges incurred on all returned products.

---

## **D. Obtaining Service**

1. Verify that your Matrox product was installed and configured according to the information in its accompanying documentation.
2. Read the "Troubleshooting" information included with the Matrox product to see if you can solve the problem yourself.
3. If you are still experiencing difficulties, please contact your dealer where you purchased your Matrox product.
4. If you must return a Matrox product, leave the configuration as it was when you were using it, and leave all identification stickers on the product. Pack the product in its original box and return to your Matrox dealer where the product was purchased, together with your proof of purchase. Your Matrox dealer will return the product for you. Alternatively, if this first option is unavailable to you, you may contact the Matrox Technical Support group who will issue an Return Merchandise Authorization (RMA) number, upon receipt of adequate proof of purchase, and inform you of shipping instructions. DO NOT RETURN THE PRODUCT TO MATROX WITHOUT MATROX'S RMA NUMBER AND EXPRESS AUTHORIZATION.

---

## **E. General**

This limited warranty shall be governed by the laws of the Province of Quebec, Canada and the federal laws of Canada applicable therein and the courts of the Province of Quebec shall have exclusive jurisdiction to hear and decide any dispute instituted by the customer in connection with this limited warranty; the customer waives, by accepting the product, its rights to institute proceedings in connection with this warranty against Matrox in any jurisdiction other than Quebec.

---

# Software license agreement

**Single User Products** This Matrox software (the “Software”) is copyrighted by Matrox Graphics Inc. All rights are reserved. The purchaser is granted a license to use the software only, subject to the following restrictions and limitations:

1. The license is for the original purchaser only, and is not transferable without written permission of Matrox.
2. The original purchaser may use the Software on a single computer owned or leased by the original purchaser. You may not use the Software on more than a single computer, even if you own or lease more than one computer, without written consent of Matrox.
3. The original purchaser may make back-up copies of the Software for his or her own use only, subject to the use limitations of this license.
4. The original purchaser may not engage in, nor permit third parties to engage in, any of the following:
  - Providing or disclosing the Software to third parties.
  - Providing use of the Software in a computer service business, network, time-sharing, multiple CPU or multi-user arrangement to users who are not individually licensed by Matrox.
  - Making alterations or copies of any kind in the Software (except as specifically permitted above).
  - Attempting to unassemble, de-compile or reverse engineer the Software in any way.
  - Granting sublicenses, leases, or other rights in the Software to others.
  - Making copies, or verbal or media translations, of the user’s guide.
  - Making telecommunication data transmissions of the Software.

Matrox reserves the right to terminate this license if there is a violation of its term or default by the Original Purchaser. Upon termination, for any reason, all copies of the Software must be immediately returned to Matrox, and the Original Purchaser shall be liable to Matrox for any and all damages suffered as a result of the violation or default.

**Limited warranty** Matrox warrants to you, for a period of 90 days normal use from your date of purchase, that:

1. The CD/disks on which the software is furnished and the documentation are not defective.
2. The Software is properly recorded upon the CD/disks included.
3. The documentation is substantially complete and contains all the information Matrox deems necessary to use the software.
4. The Software functions substantially as described in the documentation.

Matrox’s entire liability and your exclusive remedy shall be the replacement of any CD/Disks or documentation not meeting these warranties, which is returned to Matrox or an authorized dealer, together with a copy of your paid receipt. The above is the only warranty of any kind, either express or implied, including, but not limited to the implied warranties of merchantability and fitness for a particular use that is made by Matrox on this Licensed Software. In no event shall Matrox be liable to you or to any third party for consequential, special, indirect or incidental damages which you may incur as a result of using the licensed software, including, but not limited to, loss of data, or information of any kind which you may experience.

---

# Index

---

## B

BIOS 19

---

## C

Customer support 32–33

---

## E

Expansion slots 5, 13

---

## G

Graphics  
  Troubleshooting 13–24

---

## H

Hardware  
  Acceleration 12, 21

---

## M

Multi-display mode 20

---

## P

PCI 5  
PCI Express 5  
PowerDesk 12  
Primary display 19  
Product information 30–31

---

## S

Software  
  Setup 11–12  
Sound  
  Troubleshooting 26–29

---

## T

Troubleshooting 13–29  
  Extra 18–29  
  Graphics 13–24  
  Sound 26–29  
  Video 24–26

---

## V

VESA 30, 31  
VGA 30, 31  
Video  
  Troubleshooting 24–26

---

## W

Warning 4, 5, 6, 8, 16, 18, 25  
Warranty 34–35  
Web, Matrox 32

---

## **Thank you for choosing Matrox**

Please register online (<http://www.matrox.com/graphics/registration>) to be eligible for customer support, new product announcements, and information on special offers and upcoming events.

---

**USA**

---

**FCC Compliance Statement**

**Remark for the Matrox hardware products supported by this guide** This equipment has been tested and found to comply with the limits for a Class A digital device, pursuant to Part 15 of the FCC Rules. These limits are designed to provide reasonable protection against harmful interference when the equipment is operated in a commercial environment. This equipment generates, uses, and can radiate radio frequency energy and, if not installed and used in accordance with the instructions manual, may cause harmful interference to radio communications. Operation of this equipment in a residential area is likely to cause harmful interference in which case the user will be required to correct the interference at his own expense.

**WARNING** Changes or modifications to this unit not expressly approved by the party responsible for the compliance could void the user's authority to operate this equipment. The use of shielded cables for connection of the monitor to the card is required to meet FCC requirements.

---

**CANADA**

---

**(English) Industry Canada Compliance Statement**

**Remark for the Matrox hardware products supported by this guide** These digital apparatus does not exceed the Class A limits for radio noise emission from digital devices set out in the Radio Interference Regulation of Industry Canada.

**(Français) Conformité avec les exigences du ministère de l'Industrie Canada**

**Remarque sur les produits matériels Matrox couverts par ce guide** Ce présent appareil numérique n'émet aucun bruit radioélectrique dépassant les limites applicables aux appareils numériques de Classe A prescrites dans le Règlement sur le brouillage radioélectrique édicté par Industrie Canada.

---

**JAPAN**

---

**VCCI Compliance Statement**

**Remark for the Matrox hardware products supported by this guide** This is a Class A product based on the standard of the Voluntary Control Council for Interference by Information Technology Equipment (VCCI). If this equipment is used in a domestic environment, radio disturbance may occur, in which case, the user may be required to take corrective actions.

この装置は、情報処理装置等電波障害自主規制協議会（VCCI）の基準に基づくクラスA情報技術装置です。この装置を家庭環境で使用すると電波妨害を引き起こすことがあります。この場合には使用者が適切な対策を講ずるよう要求されることがあります。

---

**USA**

---

**(English) FDA (Food and Drug Administration) requirements for Laser Products**

**Remark for the Matrox hardware products supported by this guide** This product includes a 850 nm Laser Product compliant to 21CFR Subpart J Class 1.

---

**EUROPE**

---

**(English) European user's information - Declaration of Conformity**

**Remark for the Matrox hardware products supported by this guide** These devices comply with EC Directive 89/336/EEC for a Class A digital device. They have been tested and found to comply with EN55022/CISPR22 and EN55024/CISPR24. In a domestic environment these products may cause radio interference in which case the user may be required to take adequate measures. To meet EC requirements, shielded cables must be used to connect the monitor and other peripherals to the card. These products have been tested in a typical class A compliant host system. It is assumed that these products will also achieve compliance in any class A compliant system.



## **(Français) Informations aux utilisateurs Européens – Déclaration de conformité**

**Remarque sur les produits matériels Matrox couverts par ce guide** Ces unités sont conformes à la directive communautaire 89/336/EEC pour les unités numériques de classe A. Les tests effectués ont prouvé qu'elles sont conformes aux normes EN55022/CISPR22 et EN55024/CISPR24. Le fonctionnement de ces produits dans un environnement résidentiel peut causer des interférences radio, dans ce cas l'utilisateur peut être amené à prendre les mesures appropriées. Pour respecter les impératifs communautaires, les câbles de connexion entre le moniteur ou autres périphériques et la carte doivent être blindés. Ces produits ont été testés dans un système hôte typique compatible classe A. On suppose qu'ils présenteront la même compatibilité dans tout système compatible classe A.

## **(Deutsch) Information für europäische Anwender – Konformitätserklärung**

**Anmerkung für die Matrox Hardware-Produktunterstützung durch dieses Handbuch** Diese Geräte entsprechen EC Direktive 89/336/EEC für ein digitales Gerät Klasse A. Sie wurden getestet und entsprechen demnach EN55022/CISPR22 und EN55024/CISPR24. In einer Wohnumgebung können diese Produkte Funkinterferenzen erzeugen, und der Benutzer kann genötigt sein, entsprechende Maßnahmen zu ergreifen. Um EG-Anforderungen zu entsprechen, müssen zum Anschließen des Monitors und anderer Peripheriegeräte an die Karte abgeschirmte Kabel verwendet werden. Diese Produkt wurden in einem typischen, der Klasse A entsprechenden, Host-System getestet. Es wird davon ausgegangen, daß diese Produkte auch in jedem Klasse A entsprechenden System entsprechend funktionieren.

## **(Italiano) Informazioni per gli utenti europei – Dichiarazione di conformità**

**Nota per i prodotti hardware Matrox supportati da questa guida** Questi dispositivi sono conformi alla direttiva CEE 89/336/EEC relativamente ai dispositivi digitali di Classe A. Sono stati provati e sono risultati conformi alle norme EN55022/CISPR22 e EN55024/CISPR24. In un ambiente domestico, questi prodotti possono causare radiointerferenze, nel qual caso all'utente potrebbe venire richiesto di prendere le misure adeguate. Per soddisfare i requisiti CEE, il monitor e le altre periferiche vanno collegati alla scheda grafica con cavi schermati. Questi prodotti sono stati provati in un tipico sistema host conforme alla classe A. Inoltre, si dà per scontato che questi prodotti acquisiranno la conformità in qualsiasi sistema conforme alla classe A.

## **(Español) Información para usuarios europeos – Declaración de conformidad**

**Observación referente a los productos de hardware de Matrox apoyados por este manual** Estos dispositivos cumplen con la directiva de la CE 89/336/EEC para dispositivos digitales de Clase A. Dichos dispositivos han sido sometidos a prueba y se ha comprobado que cumplen con las normas EN55022/CISPR22 y EN55024/CISPR24. En entornos residenciales, estos productos pueden causar interferencias en las comunicaciones por radio; en tal caso el usuario deberá adoptar las medidas adecuadas. Para satisfacer las disposiciones de la CE, deberán utilizarse cables apantallados para conectar el monitor y demás periféricos a la tarjeta. Estos productos han sido sometidos a prueba en un típico sistema anfitrión que responde a los requisitos de la clase A. Se supone que estos productos cumplirán también con las normas en cualquier sistema que responda a los requisitos de la clase A.

---

### **EUROPE**

---

## **(English) European user's information – Directive on Waste Electrical and Electronic Equipment (WEEE)**

Please refer to the Matrox Web site ([www.matrox.com/environment/weee](http://www.matrox.com/environment/weee)) for recycling information.



## **(Français) Informations aux utilisateurs Européens – Règlementation des déchets d'équipements électriques et électroniques (DEEE)**

Se référer au site Web de Matrox ([www.matrox.com/environment/weee](http://www.matrox.com/environment/weee)) pour l'information concernant le recyclage.

## **(Deutsch) Information für europäische Anwender – Europäische Regelungen zu Elektro- und Elektronikgeräten (WEEE)**

Bitte wenden Sie sich an der Matrox-Website ([www.matrox.com/environment/weee](http://www.matrox.com/environment/weee)) für Recycling-Informationen.

## **(Italiano) Informazioni per gli utenti europei – Direttiva sui rifiuti di apparecchiature elettriche ed elettroniche (RAEE)**

Si prega di riferirsi al sito Web Matrox ([www.matrox.com/environment/weee](http://www.matrox.com/environment/weee)) per le informazioni di riciclaggio.

### **Avertissement sur l'épilepsie**

**À lire avant toute utilisation d'un jeu vidéo par vous-même ou votre enfant** Certaines personnes sont susceptibles de faire des crises d'épilepsie ou d'avoir des pertes de conscience à la vue de certains types de lumières clignotantes ou d'éléments fréquents dans notre environnement quotidien. Ces personnes s'exposent à des crises lorsqu'elles regardent certaines images télévisées ou qu'elles jouent à certains jeux vidéo. Ces phénomènes peuvent apparaître alors même que le sujet n'a pas d'antécédent médical ou n'a jamais été confronté à une crise d'épilepsie.

Si vous-même ou un membre de votre famille avez déjà présenté des symptômes liés à l'épilepsie (crise ou perte de conscience) en présence de stimulations lumineuses, veuillez consulter votre médecin avant toute utilisation.

Nous conseillons aux parents d'être attentifs à leurs enfants lorsqu'ils jouent avec des jeux vidéo. Si vous-même ou votre enfant présentez un des symptômes suivants: vertige, trouble de la vision, contraction des yeux ou des muscles, perte de conscience, trouble de l'orientation, mouvement involontaire ou convulsion, veuillez immédiatement cesser de jouer et consultez un médecin.

**Précautions à prendre dans tous les cas pour l'utilisation d'un jeu vidéo**

- Ne vous tenez pas trop près de l'écran.
- Jouez à bonne distance de l'écran de TV et aussi loin que le permet le cordon de raccordement.
- Utilisez de préférence les jeux de vidéo sur un écran de petite taille.
- Évitez de jouer si vous êtes fatigué ou si vous manquez de sommeil.
- Assurez-vous que vous jouez dans une pièce bien éclairée.
- En cours d'utilisation, faites des pauses de dix à quinze minutes toutes les heures.

## **Trademarks • Marques déposées • Warenzeichen • Marchi registrati • Marcas registradas**

Matrox Electronic Systems Ltd. /

Matrox Graphics Inc.....	Matrox <sup>®</sup> , DualHead <sup>®</sup> , CenterWINDOW <sup>™</sup> , DVDMax <sup>™</sup> , GigaColor <sup>™</sup> , ASM <sup>™</sup> , ATC <sup>™</sup> , AuroraVX3mp <sup>™</sup> , AuroraVX <sup>™</sup> , DualHead2Go <sup>™</sup> , Epica <sup>™</sup> , Extio <sup>™</sup> , G400 <sup>™</sup> , G450 <sup>™</sup> , G550 <sup>™</sup> , Marvel <sup>™</sup> , MED2mp <sup>™</sup> , MED2mp-DVI <sup>™</sup> , MED3mp-DVI <sup>™</sup> , MED4mp <sup>™</sup> , MED5mp-DVI <sup>™</sup> , MED5mp <sup>™</sup> , Millennium <sup>™</sup> , MMS <sup>™</sup> , Multi-Monitor Series <sup>™</sup> , MultiDesk <sup>™</sup> , P650 <sup>™</sup> , P650 <sup>™</sup> Low-profile, P750 <sup>™</sup> , Parhelia <sup>™</sup> , Parhelia <sup>™</sup> APVe, Parhelia-512 <sup>™</sup> , Parhelia-LX <sup>™</sup> , Parhelia HR256 <sup>™</sup> , PJ4OLP <sup>™</sup> , PowerDesk <sup>™</sup> , PowerSpace <sup>™</sup> , QID <sup>™</sup> , Quad Information Display <sup>™</sup> , RAD <sup>™</sup> , Quick Connect <sup>™</sup> , MaxVIEW <sup>™</sup> , MGA <sup>™</sup> , MGA-G100 <sup>™</sup> , MGA-G200 <sup>™</sup> , PixelTOUCH <sup>™</sup> , PrecisionCAD <sup>™</sup> , Precision SGT <sup>™</sup> , QuickDesk <sup>™</sup> , RAD2mp <sup>™</sup> , RAD3mp <sup>™</sup> , RAD9mp <sup>™</sup> , RAD PCI <sup>™</sup> , RAD PCIe <sup>™</sup> , RADQ2mp <sup>™</sup> , Rainbow Runner <sup>®</sup> , SonoVUE <sup>™</sup> , SPECTRUM <sup>™</sup> , TheatreVUE <sup>™</sup> , TripleHead <sup>™</sup> , TripleHead2Go <sup>™</sup>
Adobe Systems Inc. ....	Acrobat <sup>®</sup> , Reader <sup>®</sup>
Apple Computer, Inc. ....	Apple <sup>®</sup> , Mac <sup>®</sup> , Mac OS <sup>®</sup>
Dolby Laboratories, Inc. ....	Dolby <sup>®</sup> , Dolby Digital <sup>®</sup>
Intel Corporation .....	Intel <sup>®</sup> , Pentium <sup>®</sup>
International Business Machines Corporation .....	IBM <sup>®</sup> , VGA <sup>®</sup>
Macrovision Corporation.....	Macrovision <sup>™</sup>
Microsoft Corporation .....	Aero <sup>™</sup> , Direct3D <sup>®</sup> , DirectDraw <sup>®</sup> , DirectShow <sup>™</sup> , DirectX <sup>™</sup> , Microsoft <sup>®</sup> , MS-DOS <sup>®</sup> , PowerPoint <sup>®</sup> , Windows <sup>®</sup> , Windows NT <sup>®</sup> , Windows Server <sup>®</sup> , Windows Vista <sup>™</sup>
Silicon Graphics, Inc. ....	OpenGL <sup>®</sup>
Silicon Image, Inc.....	PanelLink <sup>™</sup>
U.S. Environmental Protection Agency.....	Energy Star <sup>™</sup>

• (English) Registered trademarks are registered in the United States, Canada, and/or other countries. All other nationally and internationally recognized trademarks and tradenames are hereby acknowledged. • (Français) Les marques déposées sont déposées aux États-Unis, au Canada et/ou dans d'autres pays. Toutes les autres marques et tous les autres noms déposés reconnus nationalement ou internationalement sont également reconnus par les présentes. • (Deutsch) Die eingetragenen Warenzeichen sind in den USA, Kanada und/oder anderen Ländern registriert. Alle sonstigen national und international bekannten Warenzeichen und Produktnamen werden hiermit anerkannt. • (Italiano) I marchi registrati sono registrati negli Stati Uniti, in Canada e/o in altri paesi. Tutti gli altri marchi registrati e nomi commerciali riconosciuti a livello nazionale e internazionale sono ugualmente riconosciuti qui. • (Español) Las marcas registradas están registradas en los EE.UU., Canadá u otros países. Por medio del presente se reconocen todas las demás marcas y nombres comerciales reconocidos a nivel nacional e internacional.

---

## **(English) Disclaimer**

THE INFORMATION IN THIS GUIDE IS SUBJECT TO CHANGE AT ANY TIME AND WITHOUT NOTICE.

Matrox Graphics Inc. reserves the right to make changes in specifications at any time and without notice. The information provided by this document is believed to be accurate and reliable. However, no responsibility is assumed by Matrox Graphics Inc. for its use; nor for any infringements of patents or other rights of third parties resulting from its use. No license is granted under any patents or patent rights of Matrox Graphics Inc.

---

## **(Français) Responsabilité**

LES INFORMATIONS CONTENUES DANS CE MANUEL PEUVENT ÊTRE MODIFIÉES À TOUT MOMENT SANS PRÉAVIS.

Matrox Graphics Inc. se réserve le droit de modifier les spécifications à tout moment sans préavis. Les informations contenues dans ce manuel sont reconnues comme étant précises et fiables. Cependant, Matrox Graphics Inc. n'assume aucune responsabilité concernant leur utilisation, ni leur contrefaçon ou les autres droits des tiers résultant de leur utilisation. Aucune licence n'est accordée sur aucun brevet ou droit d'exploiter un brevet de Matrox Graphics Inc.

---

## **(Deutsch) Haftungsablehnungserklärung**

DIE IN DIESEM HANDBUCH ENTHALTENEN ANGABEN UND DATEN KÖNNEN OHNE VORHERIGE ANKÜNDIGUNG GEÄNDERT WERDEN.

Die Matrox Graphics Inc. behält sich das Recht vor, jederzeit und ohne Ankündigung technische Daten zu ändern. Es wird keine Garantie für die Richtigkeit des Inhalts dieses Handbuchs übernommen. Weiterhin übernimmt die Matrox Graphics Inc. keinerlei Verantwortung für die Benutzung dieses Handbuchs, weder für Verstöße gegen Patentrechte noch für andere Rechte Dritter, die aus seinem Gebrauch resultieren mögen. Es werden keinerlei Lizenzrechte gewährt für sämtliche Patente oder Patentrechte der Matrox Graphics Inc.

---

## **(Italiano) Discrezionalità**

LE INFORMAZIONI CONTENUTE NEL PRESENTE DOCUMENTO SONO SOGGETTE A MODIFICHE SENZA PREAVVISO.

Matrox Graphics Inc. si riserva il diritto di apportare variazioni di qualunque tipo alle specifiche tecniche in qualunque momento e senza alcun preavviso. Le informazioni contenute in questa documentazione sono ritenute corrette e attendibili. In ogni caso, non è imputabile a Matrox Graphics Inc. nessuna responsabilità per il loro utilizzo, come nessuna violazione a brevetti o diritti di altri produttori derivante dal loro utilizzo.

---

## **(Español) Renuncia**

LA INFORMACION QUE CONTIENE EL PRESENTE MANUAL ESTA SUJETA A CAMBIOS SIN PREVIO AVISO EN CUALQUIER MOMENTO.

Matrox Graphics Inc. se reserva el derecho de realizar modificaciones en cualquier momento y sin previo aviso. La información facilitada en este documento se considera que es exacta y fiable. Sin embargo, Matrox Graphics Inc. no asume ninguna responsabilidad por su uso; ni por cualquier infracción de patentes u otros derechos de terceras partes derivados de su uso. No se concede ninguna licencia bajo cualesquiera patentes o derechos de patentes de Matrox Graphics Inc.

## **Matrox Graphics Inc.**

1055 Saint Regis Boulevard  
Dorval, Quebec, Canada H9P 2T4

Tel: (514) 822-6320

Sales: 1-800-361-1408

E-mail: [graphics.sales@matrox.com](mailto:graphics.sales@matrox.com)

Technical support:

[www.matrox.com/graphics/support](http://www.matrox.com/graphics/support)

Web site: [www.matrox.com/graphics](http://www.matrox.com/graphics)

## **Asia Pacific**

Matrox Asia Ltd.  
2006, West Tower, Shun Tak Centre  
168-200 Connaught Road C.  
Sheung Wan, Hong Kong

Sales: 852-2281-5700

Fax: 852-2537-9530

E-mail – China, Hong Kong, and Taiwan:

[Anthony.Lee@matrox.com](mailto:Anthony.Lee@matrox.com)

E-mail – All other Asia Pacific countries:

[Info-AsiaPacific@matrox.com](mailto:Info-AsiaPacific@matrox.com)

Technical support: 852-2281-5757

E-mail: [tech.asiapac@matrox.com](mailto:tech.asiapac@matrox.com)

## **United Kingdom**

Matrox UK

Chaplin House, Widewater Place  
Moorhall Road, Harefield  
Middlesex, UB9 6NS, UK

Sales: +44 (0) 1895 827300

Fax: +44 (0) 1895 827301

E-mail – UK, ROI, Benelux, France, Spain, Portugal,  
and MEA: [insales@matrox.com](mailto:insales@matrox.com)

## **Deutschland**

Matrox Electronic Systems GmbH  
Inselkammerstraße 8  
D-82008 Unterhaching bei München, Deutschland

Tel: +49 89 62170-0

Sales: +49 89 62170-444

Fax: +49 89 6149743

E-mail – Germany, Austria, Switzerland:

[Info-CentralEurope@matrox.com](mailto:Info-CentralEurope@matrox.com)

E-mail – Denmark, Finland, Norway, Sweden:

[Info-NorthernEurope@matrox.com](mailto:Info-NorthernEurope@matrox.com)

E-mail – Eastern Europe:

[Info-EasternEurope@matrox.com](mailto:Info-EasternEurope@matrox.com)

Technischer Support: +49 89 62170-333

E-mail: [TechnischerSupport@matrox.com](mailto:TechnischerSupport@matrox.com)

## **Italia**

Ufficio italiano di Matrox Graphics Inc.  
3G electronics  
Via Boncompagni, 3B  
20139 Milano, Italia

Ufficio vendite: 02-5253095

Fax: 02-5253045

E-mail: [vendite@treg.it](mailto:vendite@treg.it)

Supporto tecnico: [www.matrox.com/graphics/it/support](http://www.matrox.com/graphics/it/support)

Sito Web: [www.matroxitalia.it](http://www.matroxitalia.it)